

**Fiat Fiorino & Qubo 02/2008 >>**  
**Peugeot Bipper & Bipper Tepee 02/2008 >>**  
**Citroën Nemo & Nemo Combi 02/2008 >>**

**Partnr.: FI-024-BQ**

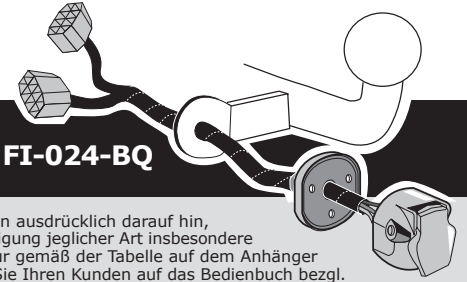

**DE**

• Einbauanleitung Elektrosatz Anhängervorrichtung mit 12-N Steckdose lt. DIN/ISO Norm 1724. • Wir weisen ausdrücklich darauf hin, dass eine unsachgemäße und nicht in einer Fachwerkstatt durchgeführte Montage einen Verzicht auf Entschädigung jeglicher Art insbesondere bezüglich des Produkthaftpflichtrechts zur Folge hat. • Technische Änderungen vorbehalten. • Widerstand nur gemäß der Tabelle auf dem Anhänger verwenden. • Achtung! Bitte lesen Sie vorab diese Anleitung, nehmen Sie diese zur Kenntnis und verweisen Sie Ihren Kunden auf das Bedienbuch bezgl. der eventuell zu treffenden Maßnahmen zum Ziehen eines Anhängers. • Bei Funktionsproblemen ist die Fehlersuche auf ca. 0,5 Stunden zu begrenzen, kontaktieren Sie die ECS Technical Support: [ts@ecs-electronics.nl](mailto:ts@ecs-electronics.nl) / 00800 22552327

**FR**

• Instructions de montage du faisceau électrique pour crochet d'attelage conforme à la norme DIN/ISO 1724 prise 12-N. • Il est expressément prévu qu'il ne saurait se prévaloir d'un quelconque préjudice contractuel ou réhibitoire si le montage avait été fait en dépit des dites instructions ou dans un garage ne disposant pas des équipements adéquats. • Sous réserve de modifications techniques. • Ne excédez pas la charge maximale, indiquée dans le tableau. • Attention! Avant de commencer le branchement, on vous prie de prendre compte des connexions à faire dans la notice, ainsi que communiquer directement à votre client les mesures à prendre pour tirer une remorque. • S'il y a des problèmes de fonctionnement, limiter la recherche de défauts à env. 30 minutes et contacter ECS l'Aide en ligne: [ts@ecs-electronics.nl](mailto:ts@ecs-electronics.nl) / 00800 22 55 23 27.

**NL**

• Montage-handleiding elektrokabelset voor trekhaak met 12-N contactdoos vlg. DIN/ISO norm 1724. • Wij wijzen er met nadruk op, dat ondeskundige en niet door een vakkundige werkplaats uitgevoerde montage tot gevolg heeft dat daardoor ieder recht op schadevergoeding, ook op wettelijke aansprakelijkheid inzake producten, vervalt. • Technische wijzigingen voorbehouden. • Gebruik alleen belasting volgens aansluittabel op het getrokken voertuig. • Opgelet! Wij verzoeken U dringend vooraf deze instructie door te nemen, hiervan kennis te nemen en uw cliënt te verwijzen naar het instructieboekje betreffende de eventueel te nemen maatregelen voor het trekken van een aanhangwagen. • Bij werkingsproblemen moet de foutencontrole tot ca. 0,5 uur beperkt worden, neem contact op met de ECS Technical Support: [ts@ecs-electronics.nl](mailto:ts@ecs-electronics.nl) / 00800 22 55 23 27.

**GB**

• Fitting instructions electric wiring kit tow bar with 12-N socket up to DIN/ISO Norm 1724. • We would expressly point out that assembly not carried out properly by a competent installer will result in cancellation of any right to damage compensation, in particular those arising by virtue of the product liability act. • Contents of these kits and their fitting manuals are subject to alteration without notice, please ensure that these instructions are read and fully understood before commencing installation. • Do not overload circuits; the maximum loads per connection are detailed in this manual. • Attention! Before Installation, please read this manual carefully and inform your customer to consult the vehicle owners manual to check for any vehicle modifications required before towing. • In the event of functional problems, troubleshooting must be limited to about 0.5 hours, contact the ECS Technical Support: [ts@ecs-electronics.nl](mailto:ts@ecs-electronics.nl) / 00800 22 55 23 27.

**ES**

• Instrucciones de montaje de kit eléctrico para enganche de remolque con caja de conexiones 12-N según norma DIN/ISO 1724. • El montaje inapropiado y efectuado por personal no cualificado originará la pérdida de todo derecho a indemnización o la expiración de toda responsabilidad civil con respecto al producto. • Nos reservamos el derecho a efectuar modificaciones técnicas. • Utilice sólo cargas de acuerdo a la tabla de conexión del vehículo remolcado. • Atención: lea atentamente este manual antes de la instalación e informe al cliente que debe consultar el manual de usuario del vehículo para conocer cualquier modificación realizada. • En caso de tener problemas con su funcionamiento, la búsqueda de errores está limitada a aprox. 0,5 horas, por lo que le recomendamos ponerse en contacto con el servicio de atención telefónica: [ts@ecs-electronics.nl](mailto:ts@ecs-electronics.nl) / 00800 22 55 23 27.

**IT**

• Istruzioni di montaggio di set di cavi elettrici per gancio da traino con zoccolo a 12 N conforme alla norma DIN/ISO 1724. • Sottolineiamo espressamente che un montaggio inadeguato ed eseguito da un'officina non specializzata ha come conseguenza il decadere di qualsiasi diritto al risarcimento danni, nonché alla responsabilità legale relativa ai prodotti. • Ci si riserva il diritto di apportare modifiche tecniche. • Utilizzare esclusivamente un carico conforme alla tabella degli allacci relativa al veicolo in questione. • Attenzione! Vi invitiamo a leggere attentamente questo manuale e a invitare a vostra volta i clienti a leggere il manuale del conducente sulle eventuali misure da prendere per l'attacco di un rimorchio. • In caso di problemi di funzionamento, la ricerca di errori dovrebbe essere limitata a circa 0,5 ore. Contattare il centralino di assistenza per i fasci di cavi: [ts@ecs-electronics.nl](mailto:ts@ecs-electronics.nl) / 00800 22 55 23 27.

**SE**

• Monteringsanvisningar elkabelsats för dragkrok med 12-N kontaktbox enligt DIN/ISO norm 1724. • Vi påpekar med eftertryck att all rätt till skadeersättning och all laglig ansvarighet förfaller om monteringen inte har utförts på rätt sätt och av en professionell verkstad. • Tekniska ändringar förbehålles. • Änvid endast belastning enligt anslutningstabellen på det dragna fordonet. • Varning! Innan installation, läs den här handboken noga och informera din kund om att läsa fordonets användarhandbok för att undersöka vilka eventuella ändringar som behöver göras på fordonet. • Vid funtionsproblem ska felsökningen begränsas till ca 0,5 timme, kontakta reservdels-helpline [ts@ecs-electronics.nl](mailto:ts@ecs-electronics.nl) / 00800 22 55 23 27.

**CZ**

• Montážní pokyny: souprava pro elektrické propojení tažné tyče s 12 - N zásuvkou do normy DIN/ISO 1724. • Výslovně zdůrazňujeme, že jakákoli montáž, která není provedená ve specializované dílně, má za následek odvolání nároků na kompenzaci jakéhokoli druhu, obzvláště vyplývajících ze zákona o odpovědnosti za způsobené škody. • Změny mohou být provedeny bez oznámení. • Používejte pouze při maximálním nabití podle tabulky na tažném vozidle. • Upozornění! Prosíme, abyste si nejdříve přečetli tyto instrukce, seznámili se s nimi a odkázali své zákazníky na příručku týkající se případných opatření, která musí být přijata pro tažení přívěsu. • Při problémech funkčnosti je třeba vyhledávání chyb omezit na cca 0,5 hodiny, kontaktujte ECS Technical Support: [ts@ecs-electronics.nl](mailto:ts@ecs-electronics.nl) / 00800 22 55 23 27.

**DK**

• Monteringsvejledninger for det elektriske ledningsføringssæt for trækstang med 12-N stikdåse, DIN/ISO, norm 1724. • Vi ønsker at gøre udtrykkeligt opmærksom på atforkert samling, der ikke er udført af et specialiseret værksted, resulterer i bortfaldelse af kompensationskrav af alle slags, i særdeles krav der måtte opstå omkring det lovligtige ansvar. • Kan ændres uden varsel. • Brug kun den maksimale belastning, i overensstemmelse med forbindelsestabelen for bugserede køretøjer. • OBS! Før installation skal denne vejledning læses omhyggeligt og din kunde skal informeres om at kigge i køretøjets håndbog for at kontrollere om der skal laves eventuelle ændringer på køretøjet inden bugsering. • Ved funktionsproblemer skal fejlsøgningen begrænses til ca. 0,5 time, kontakt ECS Technical Support: [ts@ecs-electronics.nl](mailto:ts@ecs-electronics.nl) / 00800 22 55 23 27.

**FI**

• Ohjeet vetokoukun sähkökaapelisarjan asentamiseen, jossa on DIN/ISO 1724 mukainen 12-N liitin. • Korostamme, että kaikki oikeudet vahinkokorvaukseen kuten myös valmistajan laillinen vastuu raukeavat, mikäli asennusta ei ole toteutettu oikealla tavalla eikä ammattitaitoisen asiantuntijan toimesta. • Oikeus teknisiin muutoksiin ilman erillistä huomautusta pidätetään. • Huomio! Lue tämä käyttöopas huolellisesti ennen asennusta ja tiedota asiakkaita tarkistamaan kaikki ajoneuvon muutoksen ajoneuvon omistajan käyttöoppaas ennen hinausta. • Kuormita työvirtapiiriä ainoastaan hinattavan ajoneuvon kytkentäkaavin mukaisesti. • Virhehaku on rajoitettava toiminto-ongelmien esiintyessä noin 0,5 tuntiin, ota yhteys ECS Technical Support: [ts@ecs-electronics.nl](mailto:ts@ecs-electronics.nl) / 00800 22 55 23 27.

**GR**

• Οδηγίες συναρμολόγησης ηλεκτρικού σετ καλωδίων μπάρας ρυμούλκησης με υποδοχή 12-N μέτρο DIN/ISO Κανόνας 1724. • Επισημαίνουμε κατηγορηματικά ότι οποιαδήποτε ασφαλή συναρμολόγηση, η οποία δεν έχει πραγματοποιηθεί ειδικό εργαστήριο θα οδηγήσει σε αποποίηση των αξιώσεων επιβολής αποζημιώσεων οποιασδήποτε είδους, ειδικά όσα προκύπτουν από το νόμο ευθύνης προϊόντων. • Μπορεί να τροποποιηθεί χωρίς προηγούμενη ειδοποίηση. • Χρησιμοποιείτε μόνο μέγιστο ηλεκτρικό φορτίο σύμφωνα με τον πίνακα σύνδεσης στο ρυμούλκούμενο όχημα. • Προσοχή! Πριν την εγκατάσταση, διαβάστε το εγχειρίδιο αυτό προσεκτικά και ενημερώστε τον πελάτη σας να συμβουλευτεί το εγχειρίδιο ιδιοκτητήτων οχήματος ώστε να ελέγξει τυχόν τροποποιήσεις που απαιτούνται στο όχημα πριν τη ρυμούλκηση. • Σε περίπτωση προβλημάτων λειτουργίας να περιοριστεί η αναζήτηση ασφαλών σε περί. 0,5 δευτ., επικοινωνήστε με τη γραμμή υποστήριξης ECS Technical Support: [ts@ecs-electronics.nl](mailto:ts@ecs-electronics.nl) / 00800 22 55 23 27.

**NO**

• Monteringsanviser elkabelsett for trekstang med 12-N koblingsboks ifølge DIN/ISO norm 1724. • Vi påpeker ettertrykkelig at all rett til skadeerstatning og rettslig ansvar forfaller dersom monteringen ikke er blitt utført på riktig måte og av et profesjonelt verksted. • Tekniske endringer forbeholdes. • Overskrid ikke grensene anviset i tilkoblingstabellen på tilhengeren eller det tilkoblede kjøretøyet. • OBS! Les denne bruksanvisningen nøye før installasjon. Be kunden om å rådføre seg med brukerhåndboken for kjøretøyeiere for å sjekke om kjøretøyet må modifiseres før tauing. • Ved funksjonsproblemer må feilsøket begrenses til ca. 0,5 timer, kontakt ECS Technical Support: [ts@ecs-electronics.nl](mailto:ts@ecs-electronics.nl) / 00800 22 55 23 27.

**PL**

• Instrukcje montażu zestawu okablowania elektrycznego dyszla holowniczego z 12-N stykowym gniazdem DIN/ISO 1724. • Chcielibyśmy wyraźnie zaznaczyć, iż wszelki nieprawidłowy montaż, który nie jest wykonywany w specjalistycznym warsztacie pociąga za sobą utratę możliwości dochodzenia wszelkiego typu roszczeń, w szczególności tych wynikających z odpowiedzialności producenta za swój produkt. • Podlega zmianom bez powiadomienia. • Używać tylko takiego maksymalnego obciążenia które wynika z tabliczki połączeń holowanego pojazdu. • Uwaga! Przed zainstalowaniem należy dokładnie przeczytać tę instrukcję i poinformować klienta o konieczności sprawdzenia w instrukcji posiadacza pojazdu w celu sprawdzenia przed holowaniem, czy nie wprowadzono do pojazdu jakichkolwiek zmian. • W przypadku problemów ograniczyć wyszukiwanie błędów do ok. 0,5 godziny, skontaktować się z linią serwisową [ts@ecs-electronics.nl](mailto:ts@ecs-electronics.nl) / 00800 22 55 23 27.

Einzelteilliste

Liste de pièces

Onderdelenlijst

Part list

Lista de componentes

Elenco componenti

Dellista

Seznam dílů

Del-liste

Osaluettelo

Κατάλογος εξαρτημάτων

Delliste

Lista części

DE

FR

NL

GB

ES

IT

SE

CZ

DK

FI

GR

NO

PL

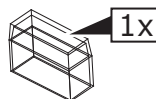
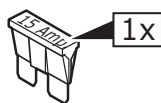
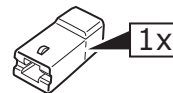
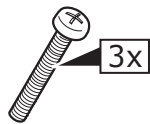
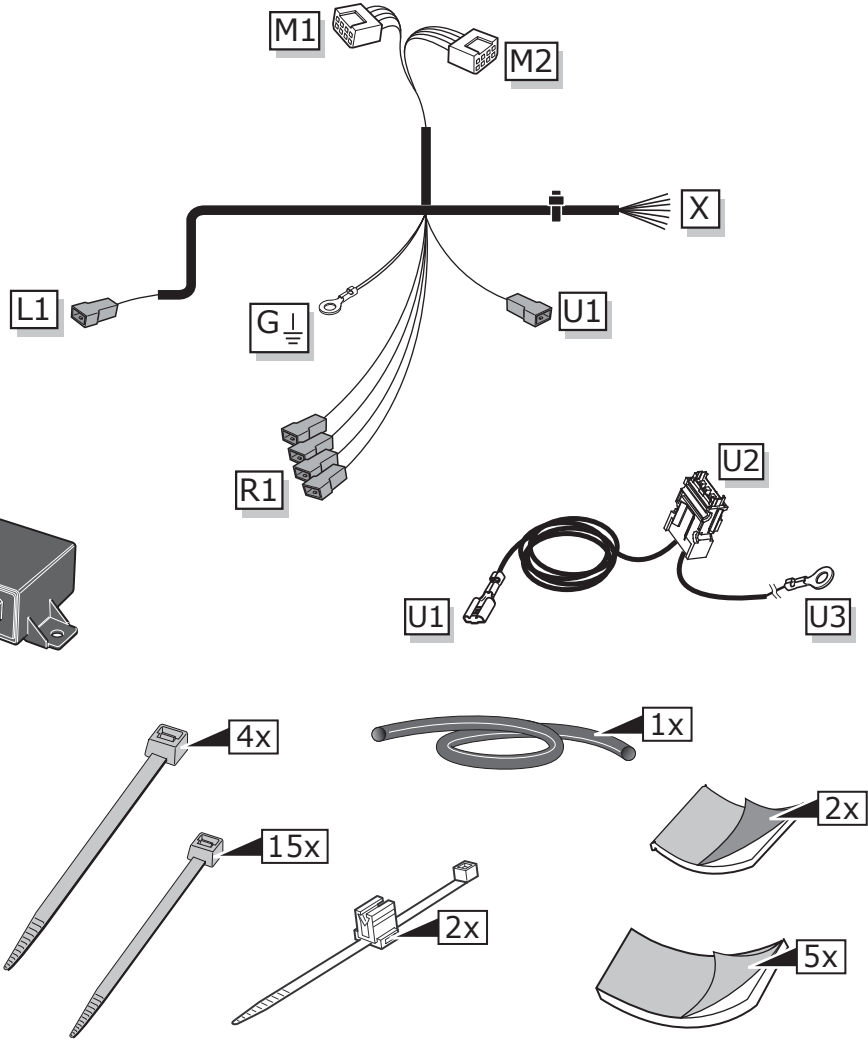
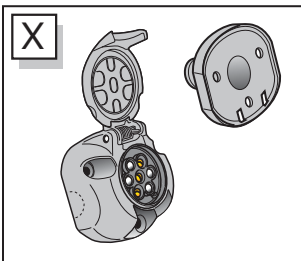
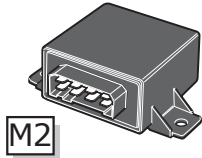
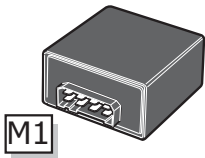
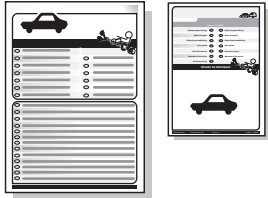
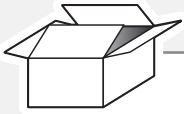

**ROUTING**

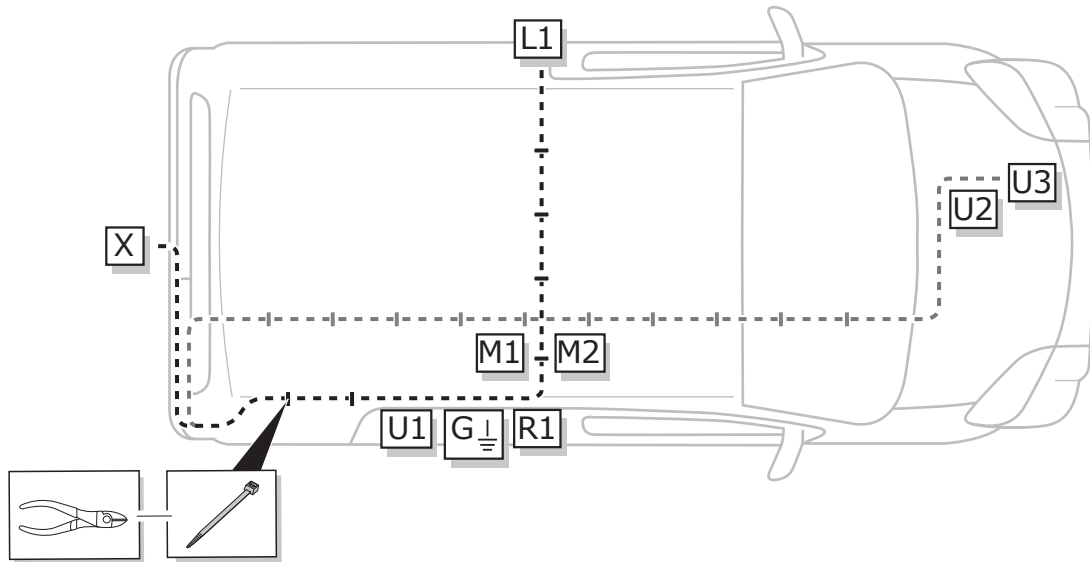

**1**

2x

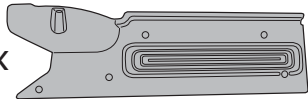

**1**

2x

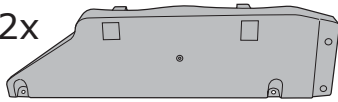

**2**

**3**

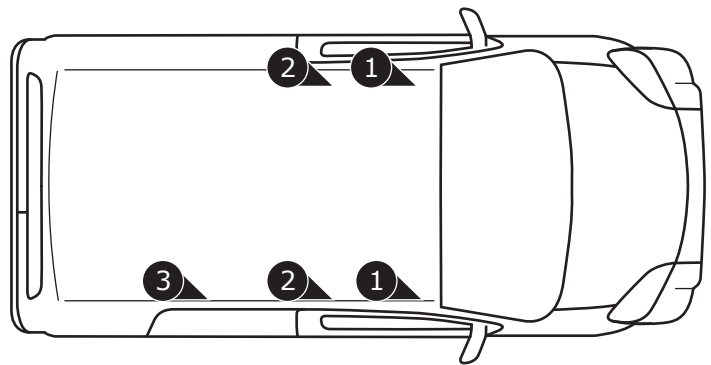
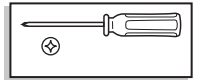
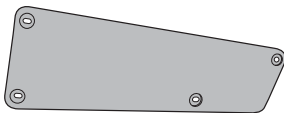

**2**

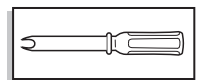
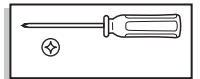
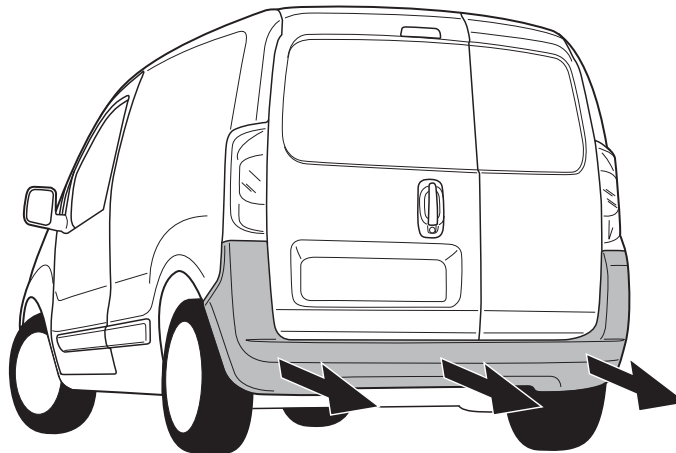

# COLOR TABLE

	(DE)	(FR)	(GB)	(NL)	(ES)	(IT)	(SE)	(CZ)	(DK)	(FI)	(GR)	(NO)	(PL)
BU	Blau	Bleu	Blue	Blauw	Azul	Blu	Blå	Modrá	Blå	Sininen	Μπλε	Blå	Niebieska
BK	Schwarz	Noir	Black	Zwart	Negro	Nero	Svart	Černá	Sort	Musta	Μαύο	Sort	Czarna
BN	Braun	Marron	Brown	Bruin	Marrón	Marrone	Brun	Hnědá	Brun	Ruskea	Καφέ	Brun	Brązowa
GN	Grün	Vert	Green	Groen	Verde	Verde	Grön	Zelená	Grøn	Vihreä	Πράσινο	Grønn	Zielona
GY	Grau	Gris	Grey	Grijs	Gris	Grigio	Grå	Šeda	Grå	Harmaa	Γκρι	Grå	Szara
OG	Orange	Orange	Orange	Oranje	Naranja	Arancione	Orange	Oranžová	Orange	Oransi	Πορτοκάλι	Orange	Pomarańczowa
RD	Rot	Rouge	Red	Rood	Rojo	Rosso	Röd	Červená	Rød	Punainen	Κόκκινο	Rød	Czerwona
WH	Weiß	Blanc	White	Wit	Blanco	Bianco	Vit	Bílá	Hvid	Valkoinen	Λευκό	Hvit	Biała
YE	Gelb	Jaune	Yellow	Geel	Amarillo	Giallo	Gul	Žlutá	Gul	Keltainen	Κίτρινο	Gul	Żółta
PK	Rosa	Rose	Pink	Rosé	Rosa	Rosa	Rosa	Růžová	Rosa	Rosa	Ροζ	Rosa	Różowa
PE	Purpur	Pourpre	Purple	Paars	Púrpura	Rosso porpora	Purper	Purpurov	Purper	Purppura	Πορφυρό	Purper	Purpurowa
DL	Dunkelblau	Bleu foncé	Dark blue	Donkerblauw	Azul oscuro	Blu scuro	Mörkblå	Tmavomodrá	Mørkeblå	Tummansininen	Σκούρο μπλε	Mørkeblå	Granatowa
DG	Dunkelgrün	Vert foncé	Dark green	Donkergroen	Verde oscuro	Verde scuro	Mörkgrön	Tmavozelená	Mørkegrøn	Tummanvihreä	Σκούρο πράσινο	Mørkegrønn	Ciemnozielona
LB	Hellblau	Bleu clair	Light blue	Lichtblauw	Azul claro	Blu chiaro	Ljusblå	Bleděmodrá	Lyseblå	Vaaleansininen	Ανοικτό μπλε	Lyseblå	Jasnoniebieska
LG	Hellgrün	Vert clair	Light green	Lichtgroen	Verde claro	Verde chiaro	Ljusgrön	Světlezelená	Lysegrøn	Vaaleanvihreä	Ανοικτό πράσινο	Lysegrønn	Jasnozielona
NL	Naturfarben	Nature	Natural colour	Naturel	Color natural	Colori naturali	Naturfärger	Přírodní	Naturfarvet	Luonnonväri	Φυσικά χρώματα	Naturfarger	Barwy
SB	Himmelblau	Bleu ciel	Sky blue	Hemelsblauw	Azul cielo	Celeste	Himmelsblå	Blankytná	Himmelblå	Taivaansininen	Γαλάζιο	Himmelblå	Błękitna
T	Gelbbraun	Marron-jaune	Yellow brown	Geelbruin	Amarillo-marrón	Giallomarrone	Gulbrun	Žlutohnědá	Gulbrun	Keltaisenruskea	Κίτρινοκαφέ	Gulbrun	Żółtobrązowa
VT	Violett	Violet	Violet	Violet	Violeta	Viola	Violett	Fialová	Violet	Violetti	Μοβ	Fiolett	Fioletowa

3

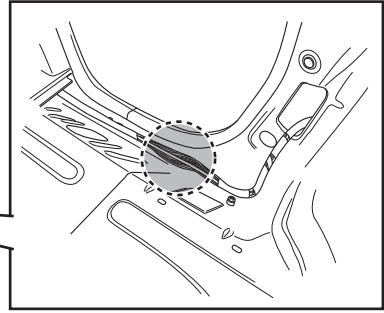
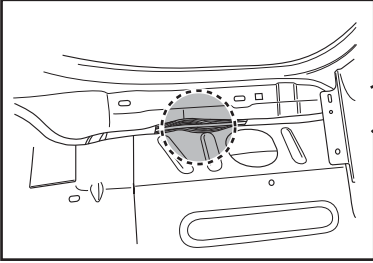
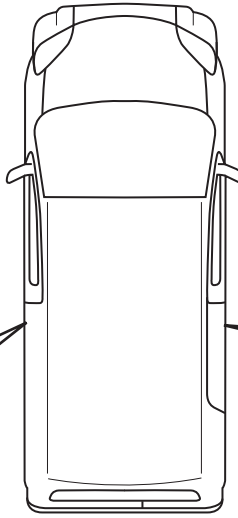
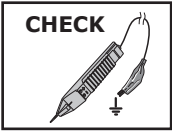

4

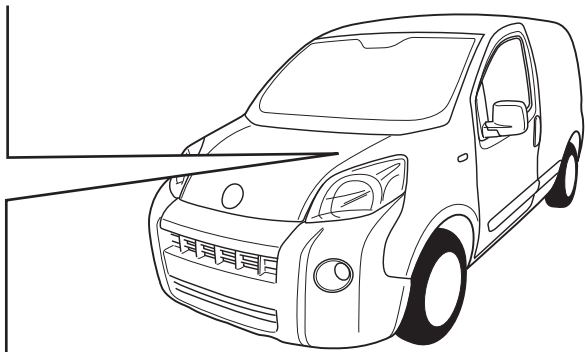
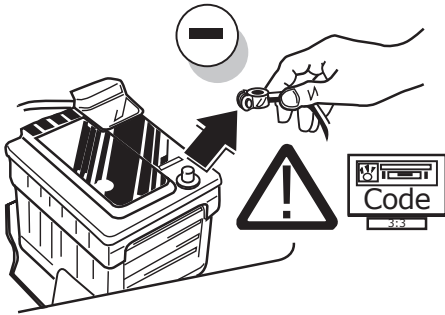

5

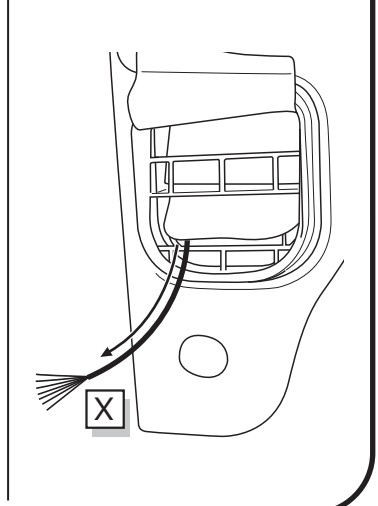
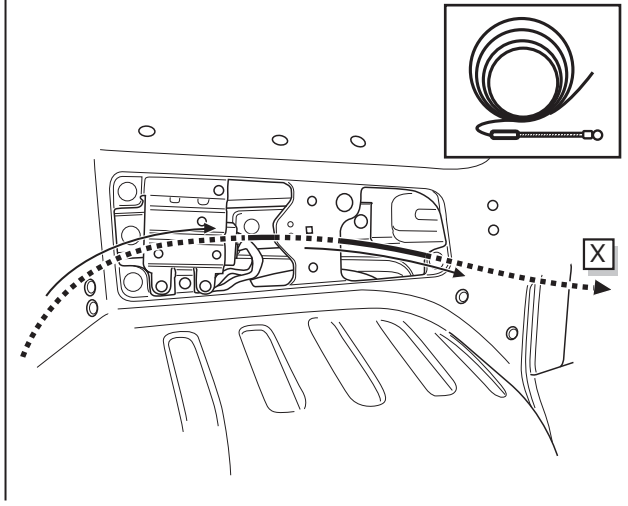
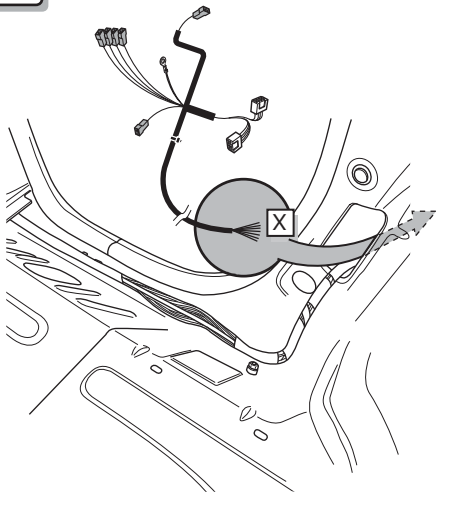

6

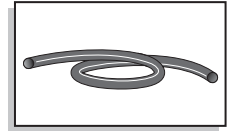
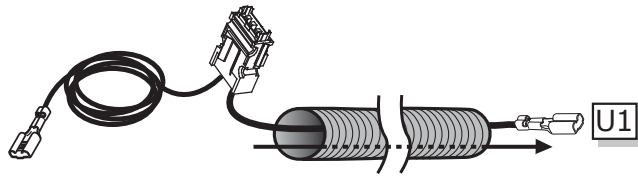

7

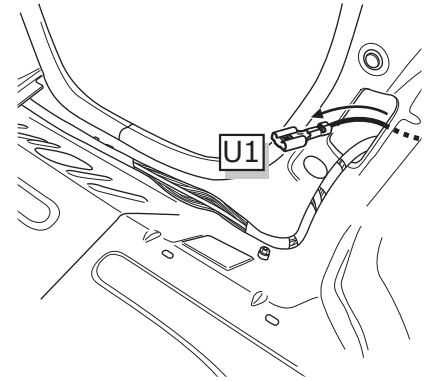
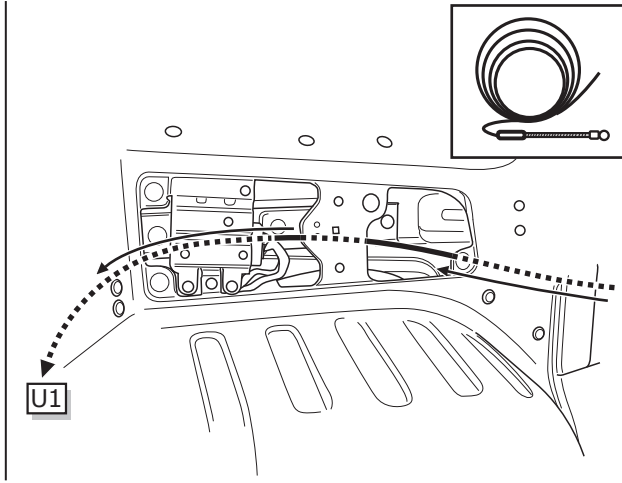
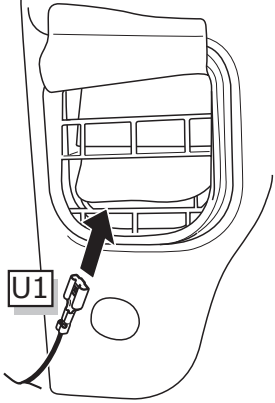

A

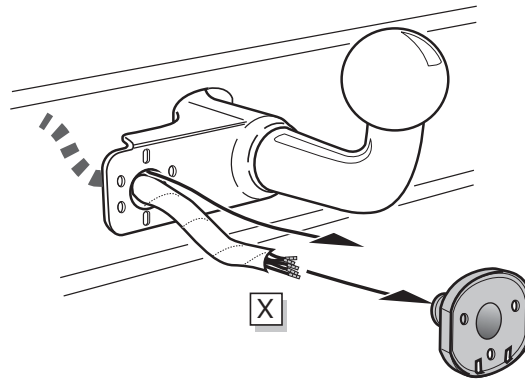

## INFO

- (DE) Anschluss Steckdose
- (FR) Connection de la prise
- (NL) Contactdoos aansluiting
- (GB) Socket connection
- (ES) Conexión de la caja de enchufe
- (IT) Allaccio zoccolo
- (SE) Anslutning kontaktdosa

- (CZ) Objímkový konektor
- (DK) Stikdåse forbindelse
- (FI) Pistorasia liitäntä
- (GR) Υποδοχή σύνδεσης
- (NO) Tilkobling koblingsboks
- (PL) Połączenie przez gniazdo



Page 11

B

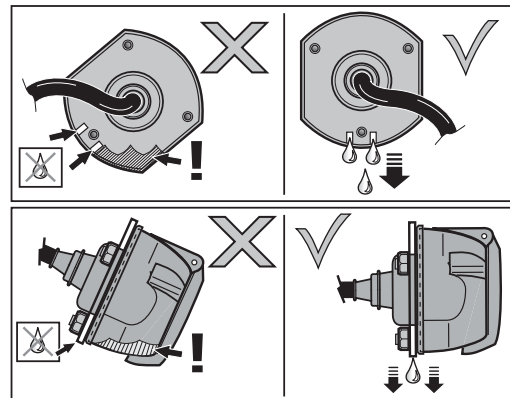
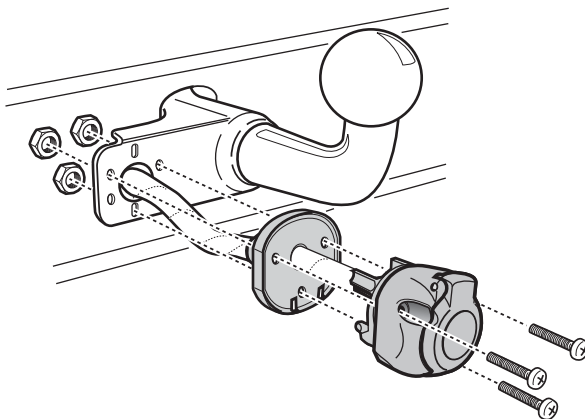

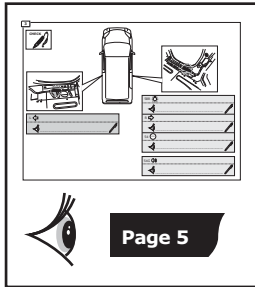
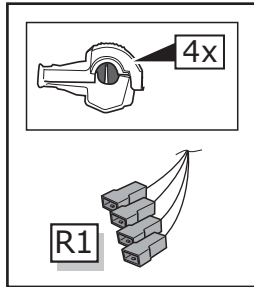
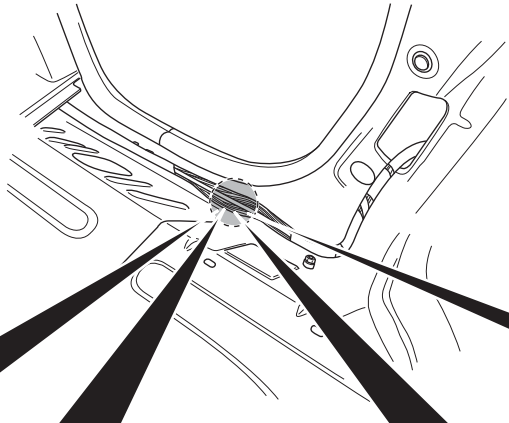
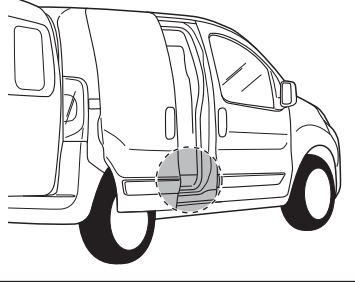

1 R →

2 R →

3 R →

1 58R ☀

2 58R ☀

3 58R ☀

1 54 STOP

2 54 STOP

3 54 STOP

1 54G ⚡

2 54G ⚡

3 54G ⚡

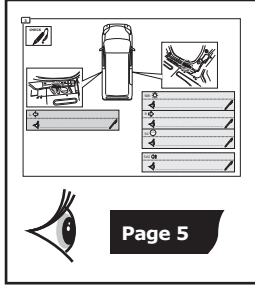
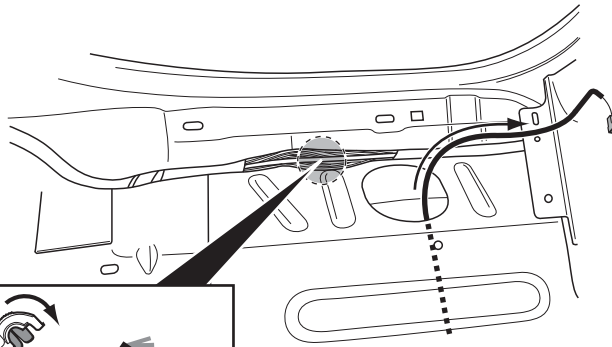
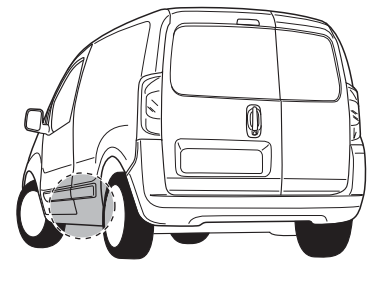

1 L ←

2 L ←

3 L ←

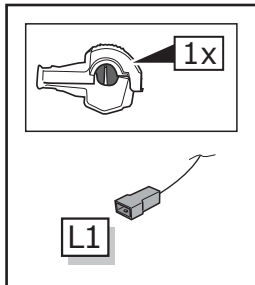

10

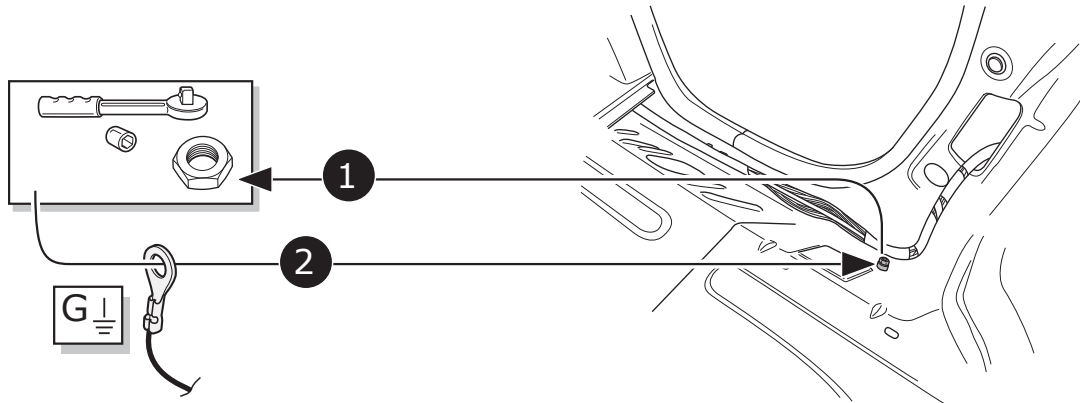

11

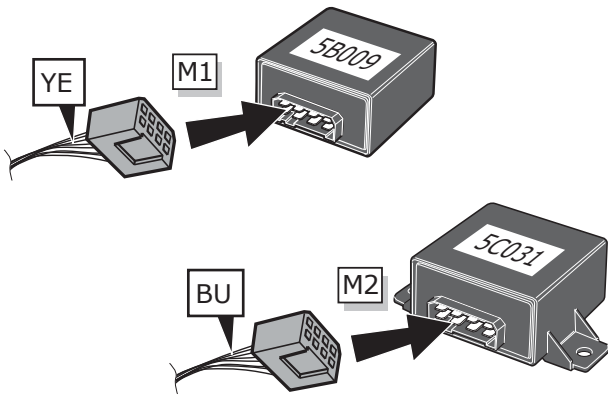

12

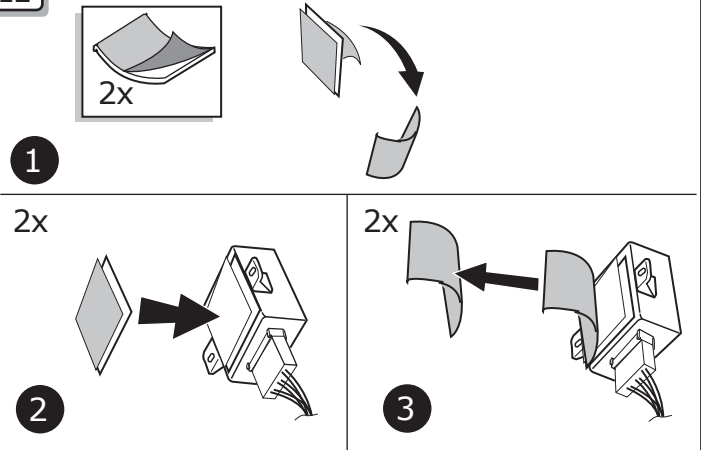

13

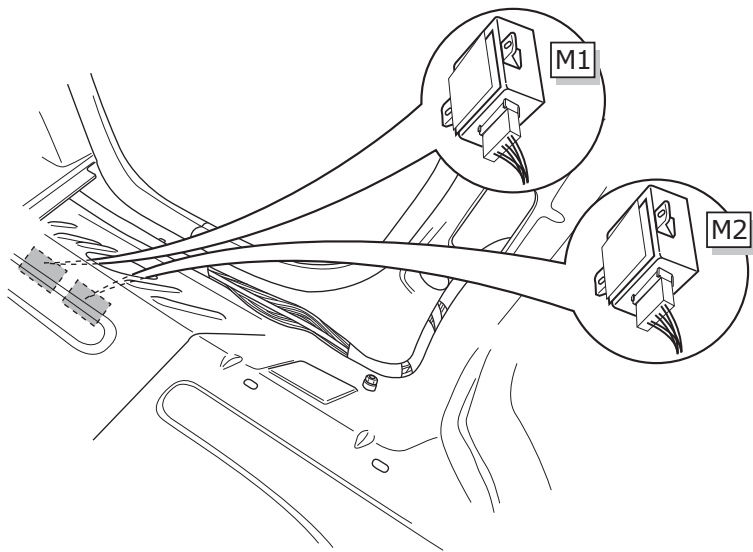
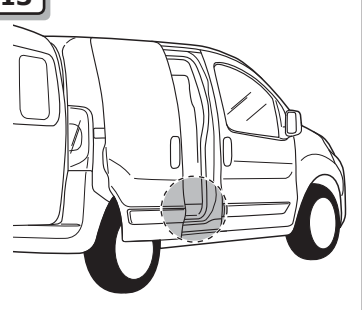

14

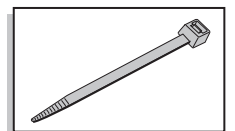
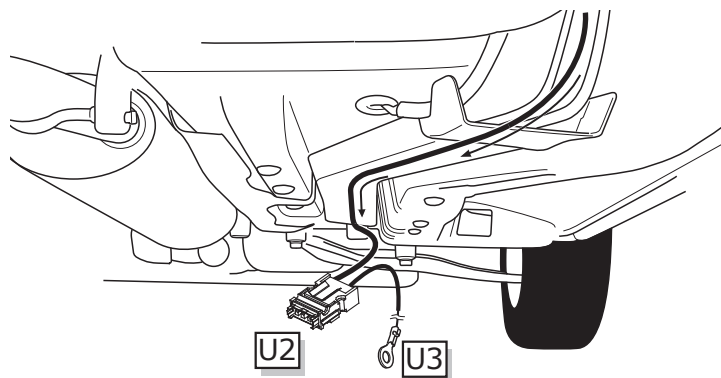



15

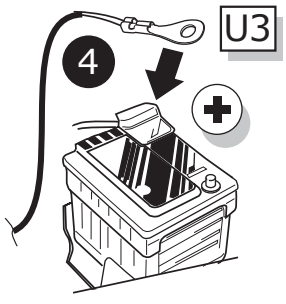
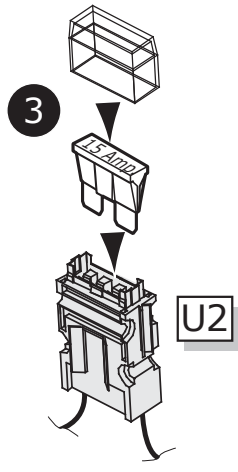
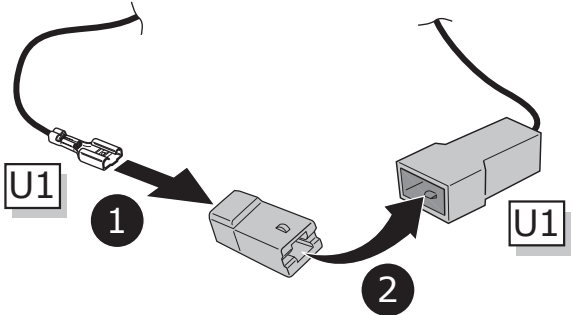

16

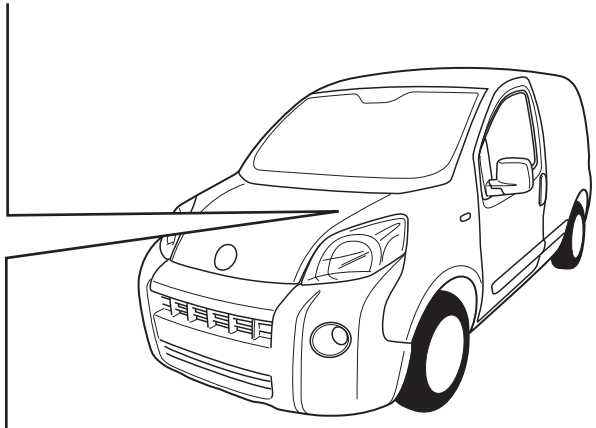
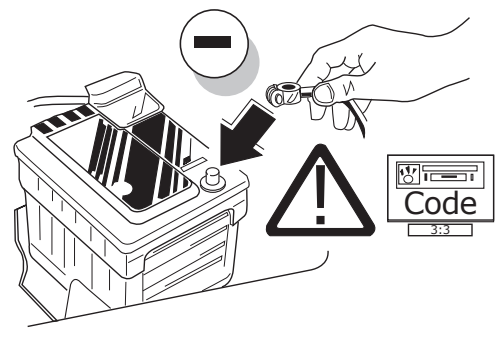

17

**Functional test**

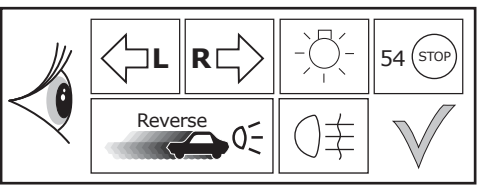

**WARNING**

**LIGHT MATE®**

**ECS** part no.  
**LIGHTMATE II**  
**LIGHTMATE III**

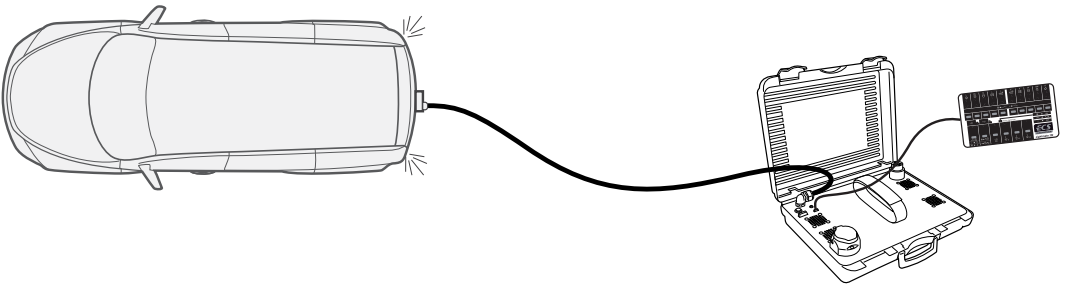
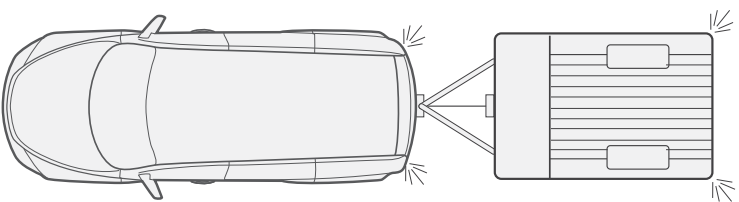

**INFO**

- Ⓧ Einzelteile wieder einbauen
- Ⓧ Remonter les pièces démontées
- Ⓧ Terug plaatsen onderdelen
- Ⓧ Reinstall linings
- Ⓧ Reinstalar componentes
- Ⓧ Rimetti a posto componenti
- Ⓧ Sätt tillbaka delar

- Ⓧ Znovu zasuňte obložení
- Ⓧ Påsæt beklædningen
- Ⓧ Asenna verhoilut takaisin
- Ⓧ Τοποθετήστε ξανά τις επενδύσεις
- Ⓧ Sett tilbake deler
- Ⓧ Założyć wykładzinę

**INFO**

**Products & Service:** <https://www.ecs-electronics.nl/test-equipment>

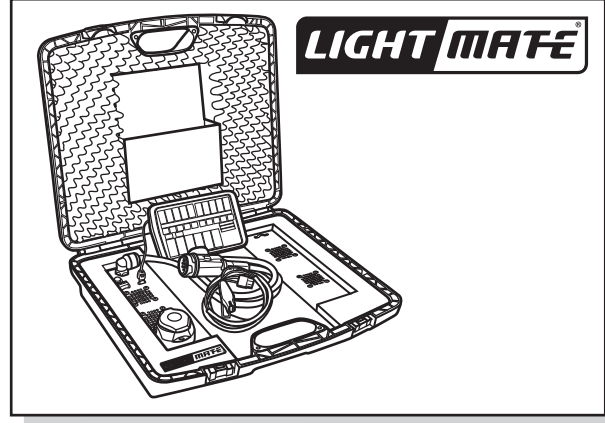
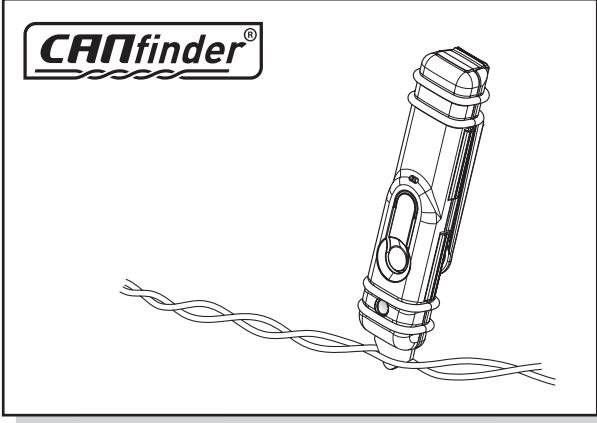

**INFO**

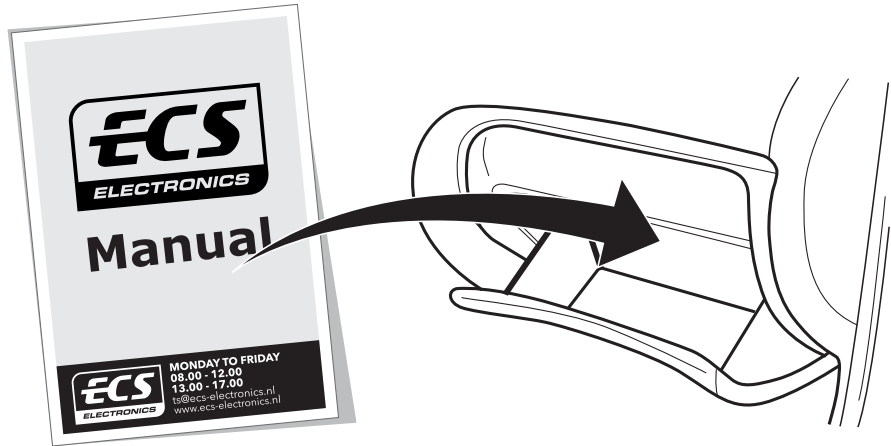

**FITTERS  
TECHNICAL  
SUPPORT**



**MONDAY TO FRIDAY  
08.00 - 12.00  
13.00 - 17.00**

ts@ecs-electronics.nl  
www.ecs-electronics.nl  
tel: +31 (0)76 573 0020

**INFO**

- (DE) Anschluss Steckdose      (ES) Conexión de la caja de enchufe      (CZ) Objímkový konektor      (GR) Υποδοχή σύνδεσης
- (FR) Connection de la prise      (IT) Allaccio zoccolo      (DK) Stikdåse forbindelse      (NO) Tilkobling koblingsboks
- (NL) Contactdoos aansluiting      (SE) Anslutning kontaktdosa      (FI) Pistorasia liitäntä      (PL) Połączenie przez gniazdo
- (GB) Socket connection

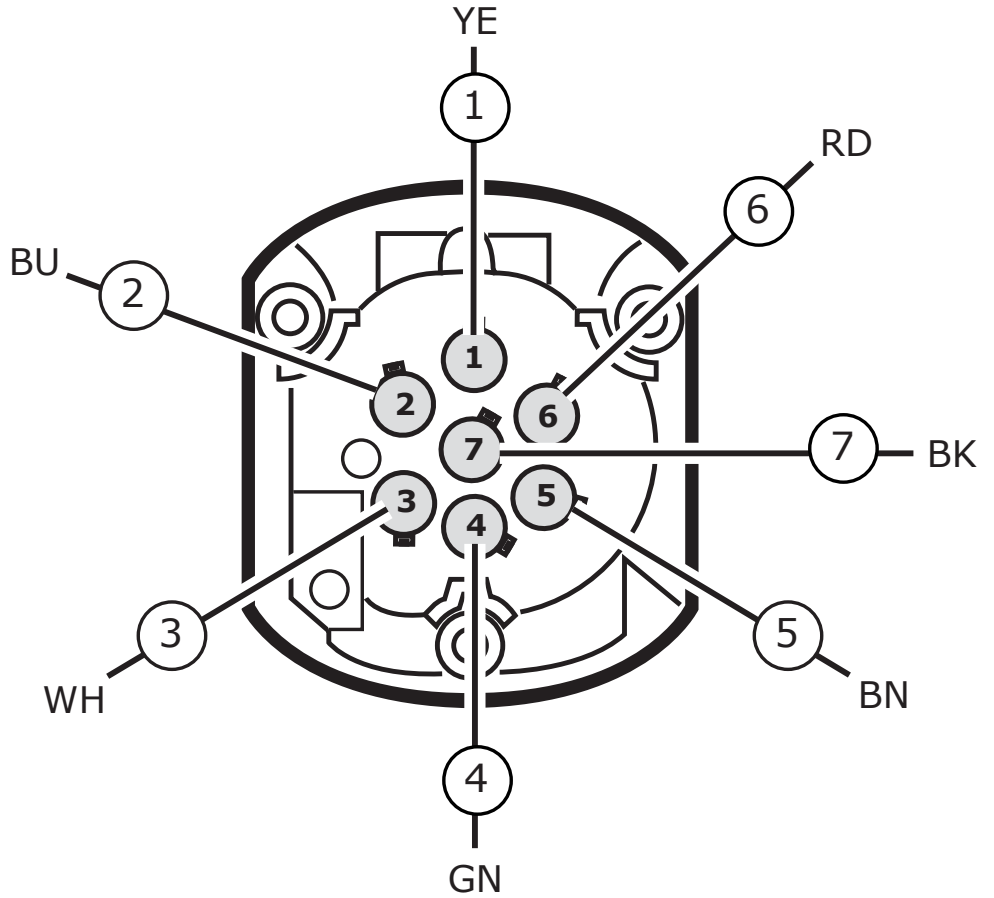
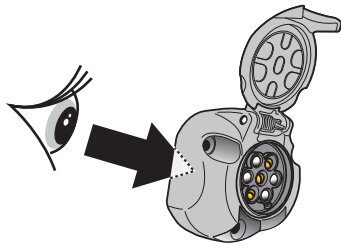

- (DE) Anschluss Steckdose      (ES) Conexión de la caja de enchufe      (CZ) Objímkový konektor      (GR) Υποδοχή σύνδεσης
- (FR) Connection de la prise      (IT) Allaccio zoccolo      (DK) Stikdåse forbindelse      (NO) Tilkobling koblingsboks
- (NL) Contactdoos aansluiting      (SE) Anslutning kontaktdosa      (FI) Pistorasia liitäntä      (PL) Połączenie przez gniazdo
- (GB) Socket connection

DIN/ISO 1724							
Pmax	21W	21W		21W	42W	3x21W	42W
	YE	BU	WH	GN	BN	RD	BK

**COLORTABLE**

	BK	BN	BU	GY	GN	WH	YE	OG	PE	PI	RD
(DE)	Schwarz	Braun	Blau	Grau	Grün	Weiß	Gelb	Orange	Violett	Rosa	Rot
(FR)	Noir	Marron	Blue	Gris	Vert	Blanc	Jaune	Orange	Violet	Rose	Rouge
(NL)	Zwart	Bruin	Blauw	Grijs	Groen	Wit	Geel	Oranje	Paars	Roze	Rood
(GB)	Black	Brown	Blue	Grey	Green	White	Yellow	Orange	Purple	Pink	Red
(ES)	Negro	Marrón	Azul	Gris	Verde	Bianco	Amarillo	Naranja	Morado	Rosa	Rojo
(IT)	Nero	Marrone	Blu	Grigio	Verde	Bianco	Giallo	Arancione	Viola	Rosa	Rosso
(SE)	Svart	Brun	Blå	Grå	Grön	Vit	Gul	Orange	Lila	Rosa	Röd
(CZ)	Černá	Hnědá	Modrá	Šedá	Zelená	Bílá	Žlutá	Oranžová	Fialová	Růžová	Červená
(DK)	Sort	Brun	Blå	Grå	Grøn	Hvid	Gul	Orange	Lilla	Pink	Rød
(FI)	Musta	Ruskea	Sininen	Harmaa	Vihreä	Valkoinen	Keltainen	Oranssi	Purppura	Vaaleanpunainen	Punainen
(GR)	Μαύρο	Καφέ	Μπλε	Γκρι	Πράσινο	Λευκό	Κίτρινο	Πορτοκαλί	Μοβ	Ροζ	Κόκκινο
(NO)	Svart	Brun	Blå	Grå	Grønn	Hvit	Gul	Oransje	Lilla	Rosa	Rød
(PL)	Czarny	Brazowy	Niebieski	Szary	Zielony	Biały	Żółty	Pomarańczowy	Purpurowy	Różowy	Czerwony